

Industrial Fiber Optic Networking

For Factory Automation and Process Control

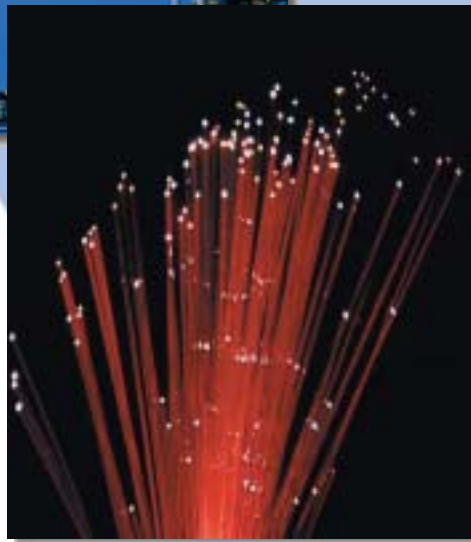

Use Fiber Optic Networking to protect your critical systems.



Fiber Optic Products

- PLC Modems
- Ethernet Connectivity
- Multiplexers
- Analog/Digital Links
- Training/Service



Weed Instrument

Fiber Optics



*ISO 9001
Certified*

EOTec

Overview of Networking System

Why Fiber Optics?

Fiber optics can be found in many applications, from network backbones that power the Internet to manufacturing facilities, to subsea communication networks on drilling rigs. The information carrying capacity of an optical fiber is far greater than it is for copper wire, coaxial cables, and microwave links. Optical fibers are very small, lightweight, resist corrosion, and are immune to electrical noise from lightning storms and electromagnetic interference (EMI/RFI). In addition, fiber optic cables do not carry electrical energy and are approved for hazardous locations. The cost of fiber optic cable and its associated connectors and hardware has decreased steadily over the years. Today, the benefits of fiber optics can far outweigh the costs making fiber optic communications the preferred choice for industrial factory automation and process control networks.

Commercial vs. Industrial Fiber Optic Products

Most process plants and factories have unique requirements for communications networks that differ from those of a commercial network. Industrial network components must withstand harsher environmental conditions such as extreme temperature ranges, lightning strikes, electromagnetic interference, and hazardous locations just to name a few.

Mounting and space requirements are also an issue since industrial networking components must be mounted in the same control panel with other control equipment. At Weed Instrument, our goal is to meet the demanding requirements of industrial communication networks. The modular EOTec brand of industrially hardened fiber optic communication products addresses these issues and provides optimal solutions for factory automation and process control.

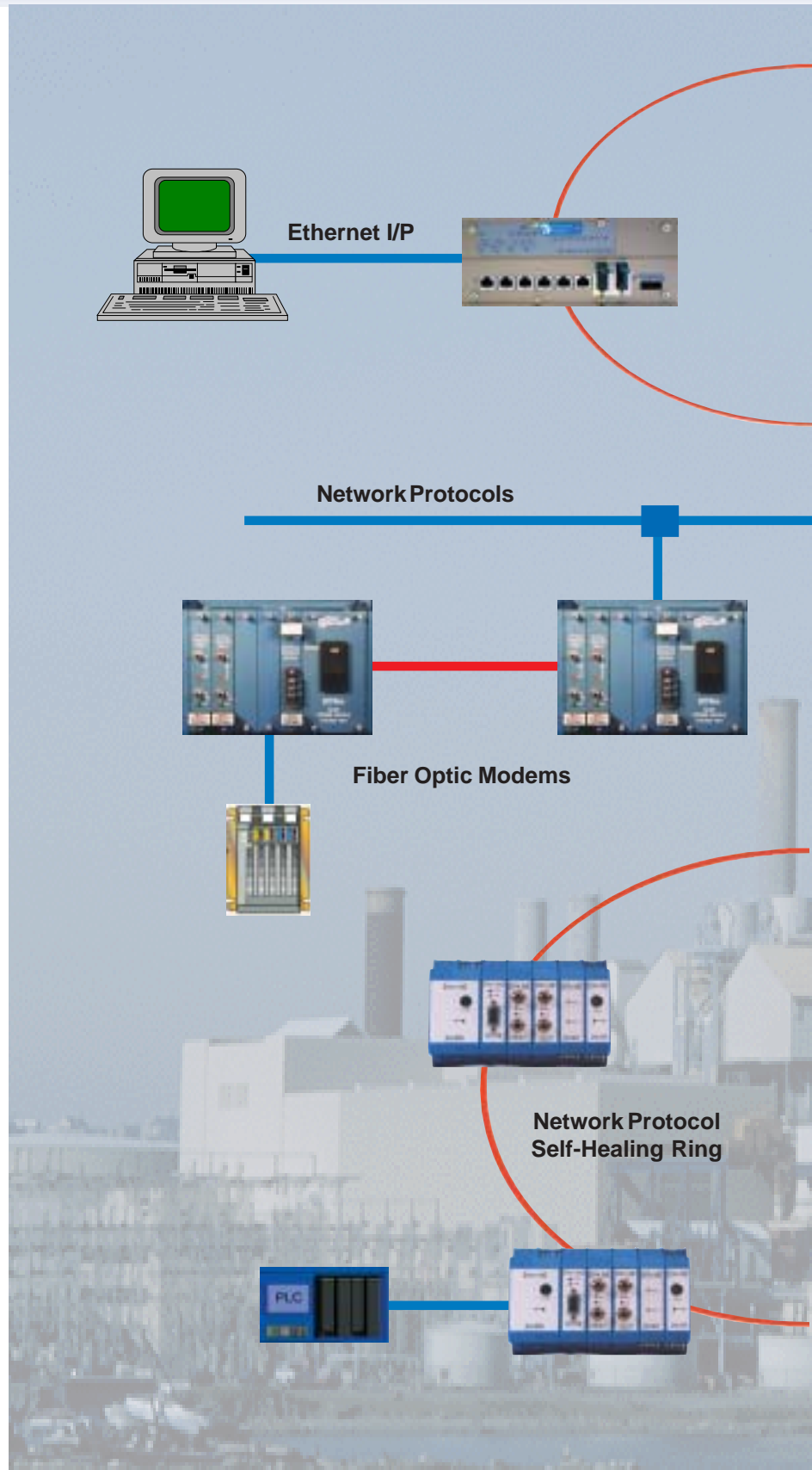

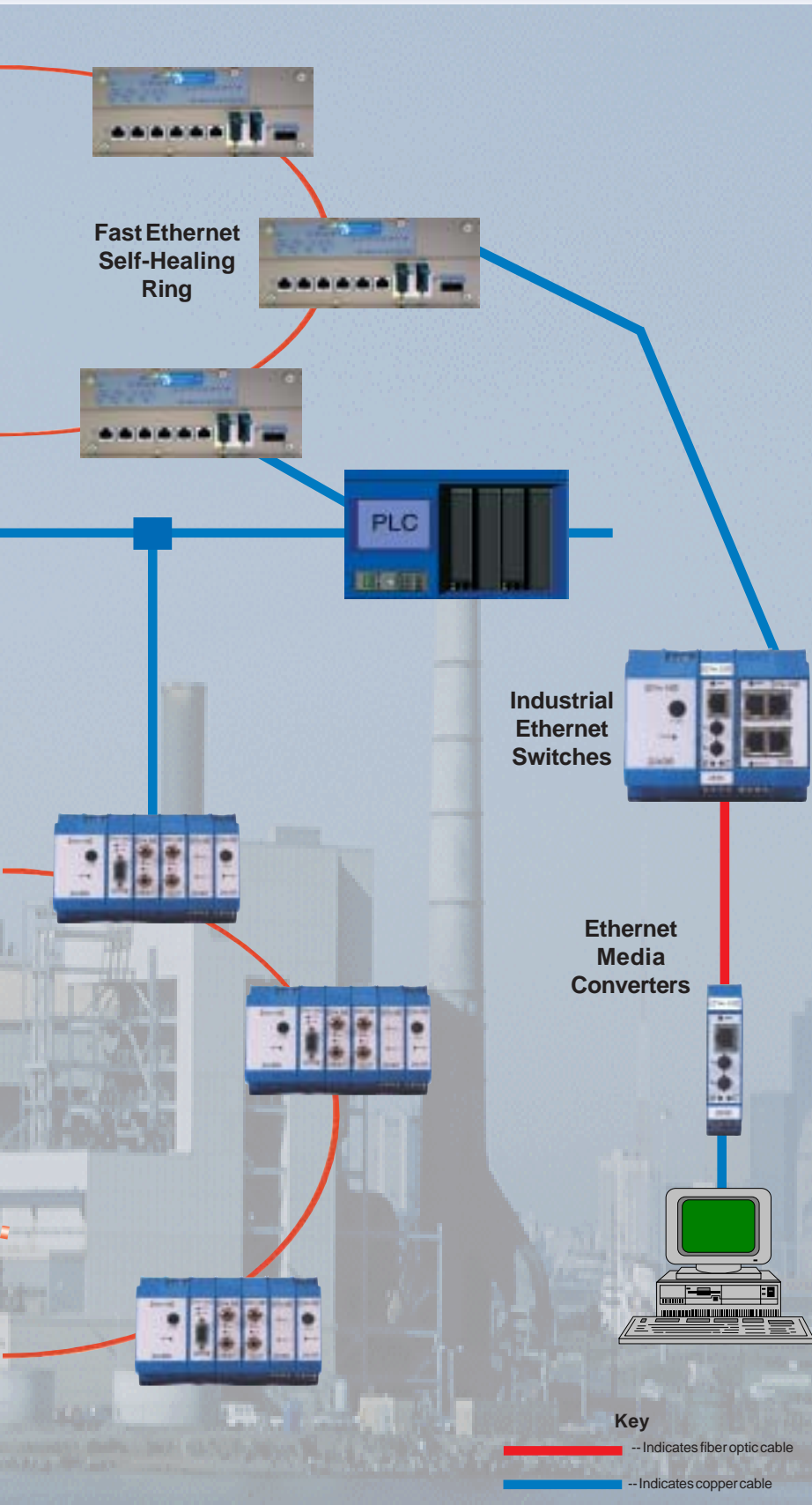

Network Protocols

The PLC has been on the forefront of factory automation for several decades and there are many different network protocols in use today. Network protocols are either open or proprietary. Some prominent proprietary protocols supported by Weed Instrument are Rockwell Automation's DH+, Schneider Electric's Modbus Plus™ and GE Fanuc's Genius® Bus. Open protocols include Ethernet TCP/IP, Profibus, ControlNet™ and DeviceNet™. Weed Instrument supports the most common protocols in use today for industrial PLC networks and Ethernet Connectivity.

Ethernet Connectivity

Ethernet is swiftly being adopted by the industrial automation and control industry. Ethernet addresses many of the requirements of proprietary PLC buses, with the added advantages of widespread usage and lower costs due to high volumes. Weed Instrument is continually developing new fiber optic products to support Ethernet and other emerging industrial network protocols.

"EOTec" is a registered trademark of Weed Instrument Co. The EOTec product line is manufactured and distributed by Weed Instrument Co. "Genius" is a registered trademark of GE-FANUC. "ControlNet" is a trademark of ControlNet International Ltd. "Modbus Plus" is a trademark of Modicon. "DeviceNet" is a trademark of O.D.V.A.

EOTec 2000 Modular System

Modular expandable fiber optic system for industrial networks

Power Supplies

Power supplies for AC or DC power sources.

Electrical Interface Modules

Electrical Interface modules compatible with all major communications standards



Hot-Swappable, bus compatible Redundant Power Supplies with diagnostic outputs to eliminate single point of failure, reducing the risk of significant costly system down-time

Pluggable Screw Terminals or industry standard connectors for all copper cable connections

System diagnostic indicators for continuous monitoring during operation

35mm DIN-Rail mounting for compact efficient design with smaller space and less power

Lightweight interchangeable modules facilitate custom configurations, easy expansion and reconfiguration

Extended temperature range (-40 to 85°C) for harsh industrial applications

*Class I, Division 2, CE Marked
UL recognized power supplies*

Self-Healing Ring Modules

Patented Self-Healing Ring modules provide a "NO DATA LOSS" media redundancy solution for highly reliable communications

Optical Interface Modules

Cascade up to five optical engines on one power supply to achieve the popular STAR topology

Ethernet Connectivity

Ethernet to Fiber Media Converters, Switches

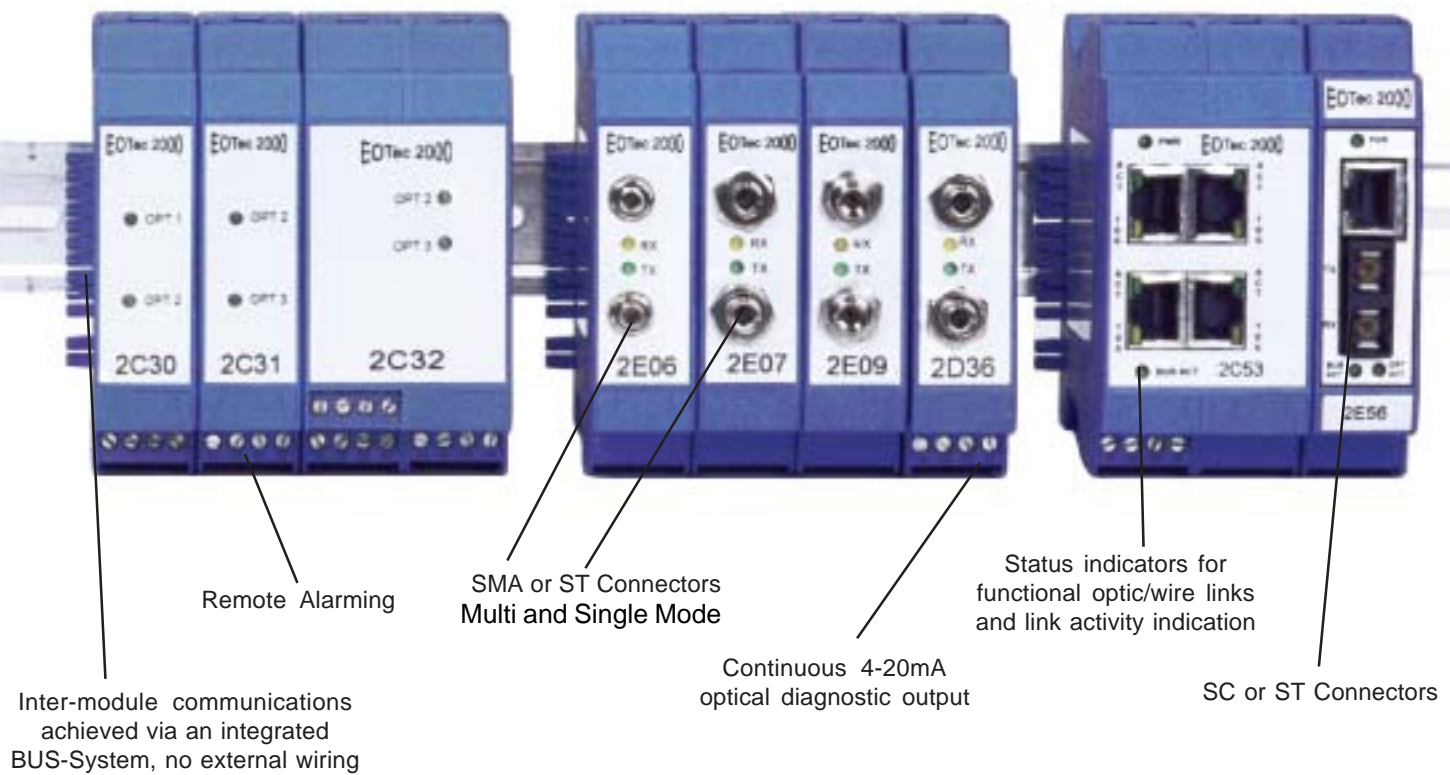

Network Topology capabilities beyond the limitations of wire-cable including Point-to-Point, Daisy Chain, Star and Self-Healing Ring

Optical and Electrical compatibility with EOTec 6000 modems

EOTec 2000 Fiber Optic Modems

Electrical Interface Modules

The Electrical Interface Module connects the EOTec 2000 system to factory networking communication devices. It provides electrical interface conditioning for data transmission over the fiber optic network.

The basic modem configuration consists of a Power Supply, an Electrical Interface, and an Optical Interface Module. However, additional modules may be added to configure Daisy Chain, Star and Self-Healing Ring topologies and provide redundancy.



RS-232
RS-485

Model Number	2C02	2C07	2C10
Protocol and extra features	GE Genius/Remote I/O	Reliance R-Net/ Remote I/O	RS-232 or RS-485 Multi-drop
Communications Data Rate	153.6K Baud Extended	800K Baud	RS-232: 9.6K-115K Baud RS-485: 9.6K-230K Baud Half Duplex
Copper Cable Connector	Pluggable Screw Terminal 12 to 24 AWG (0.5-2.4mm) Cage-Clamp	BNC	Pluggable Screw Terminal 12 to 24 AWG (0.5-2.4mm) Cage-Clamp
Copper Cable End Termination	External (user supplied)	Internal - 75 ohms	RS-232: N/A RS-485: External (user supplied)
Maximum Devices and Copper Cable Length Supported per Module	32 Units, 3500ft (1km)	1 Unit, 200ft (50m)	RS-232: 1 Unit, 50ft (15m) RS-485: 30 Units, 4000ft (1.2km)

Electrical Interface Modules - Common Features

Ambient Conditions: -40 to 85°C Operational, 0 to 95% Rel. Humidity Non-Condensing

Power Requirement (Bus): 9VDC @ 200mA Max per module

Power Indicator: Green LED

Communications Activity Indicator: Amber LED

Certifications: FM Approved Class I, Division 2, Groups A, B, C & D (selected models only)

Note: Weed Instrument is constantly developing new EOTec modules for different protocols. Please visit our website at www.weedinstrument.com for an updated list of the most current modules.

EOTec 2000 Fiber Optic Modems



	2C14	2C29	2C21	2C22/2C23
	Modicon Remote I/O	Modicon Modbus Plus	DeviceNet	Profibus - DP 2C23 - Self-Healing Ring and External 24 VDC pwr.
	1.54M Baud	1.0M Baud	125kbps	9.6K, 19.2K, 45.45K, 93.75K, 187.5K, 500K, 1.5M, 3.0M, 6.0M and 12.0M
	F-Type	DB-9 Pin	Pluggable, Phoenix Contact, 5 Position in Line, Screw Terminal Block, Dual Wire Entries, Accepts 12 to 24 AWG	DB-9 Pin
	Internal, 75 Ohms	External (user supplied)	External (user supplied)	External (user supplied)
	20 dB of cable and tap loss	Per Modbus Plus Specifications	Per DeviceNet Specifications	Per Profibus Specifications

Mechanical Specifications:

Single-width EOTec 2000 Modules (Includes most Electrical and Optical Modules). See Power Supply section for double-width dimensions. Mounting: 35mm DIN Rail Weight: <9oz (250g)

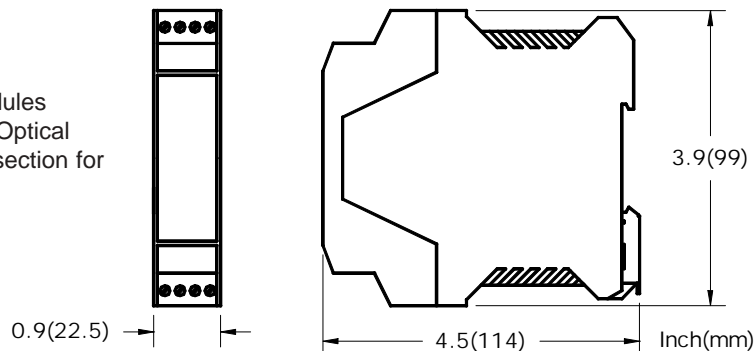

See next page for more Electrical Interface Modules



EOTec 2000 Fiber Optic Modems

Electrical Interface Modules (cont.)



Model Number	2C12	2C15	2C20
Protocol and extra features	A-B DH & DH+ & Remote I/O	A-B DH-485	ControlNet
Communications Data Rate	57.6K, 115.2K and 230.4K Baud Jumper selectable	19.2K Baud	5.0M Baud
Copper Cable Connector	Pluggable Screw Terminal 12 to 24 AWG (0.5-2.4mm) Cage-Clamp	Pluggable Screw Terminal 12 to 24 AWG (0.5-2.4mm) Cage-Clamp	BNC
Copper Cable End Termination	External (user supplied)	External (user supplied)	External (user supplied)
Maximum Devices and Copper Cable Length Supported per Module	60 Units, 10,000ft (3km)	Per DH-485 Specifications (32 Devices/4000 ft.)	Per ControlNet Specifications

Electrical Interface Modules - Common Features

Ambient Conditions: -40 to 85°C Operational, 0 to 95% Rel. Humidity Non-Condensing
Power Requirement (Bus): 9VDC @ 200mA Max per module
Power Indicator: Green LED
Communications Activity Indicator: Amber LED
Certifications: FM Approved Class I, Division 2, Groups A, B, C & D (selected models only)

EOTec 2000 Fiber Optic Modems

ControlNet - Application Diagram

This diagram shows how to use the 2C32 Self-Healing Ring ControlNet module to connect a redundant fiber optic ring on ControlNet's redundant A and B communication channels.

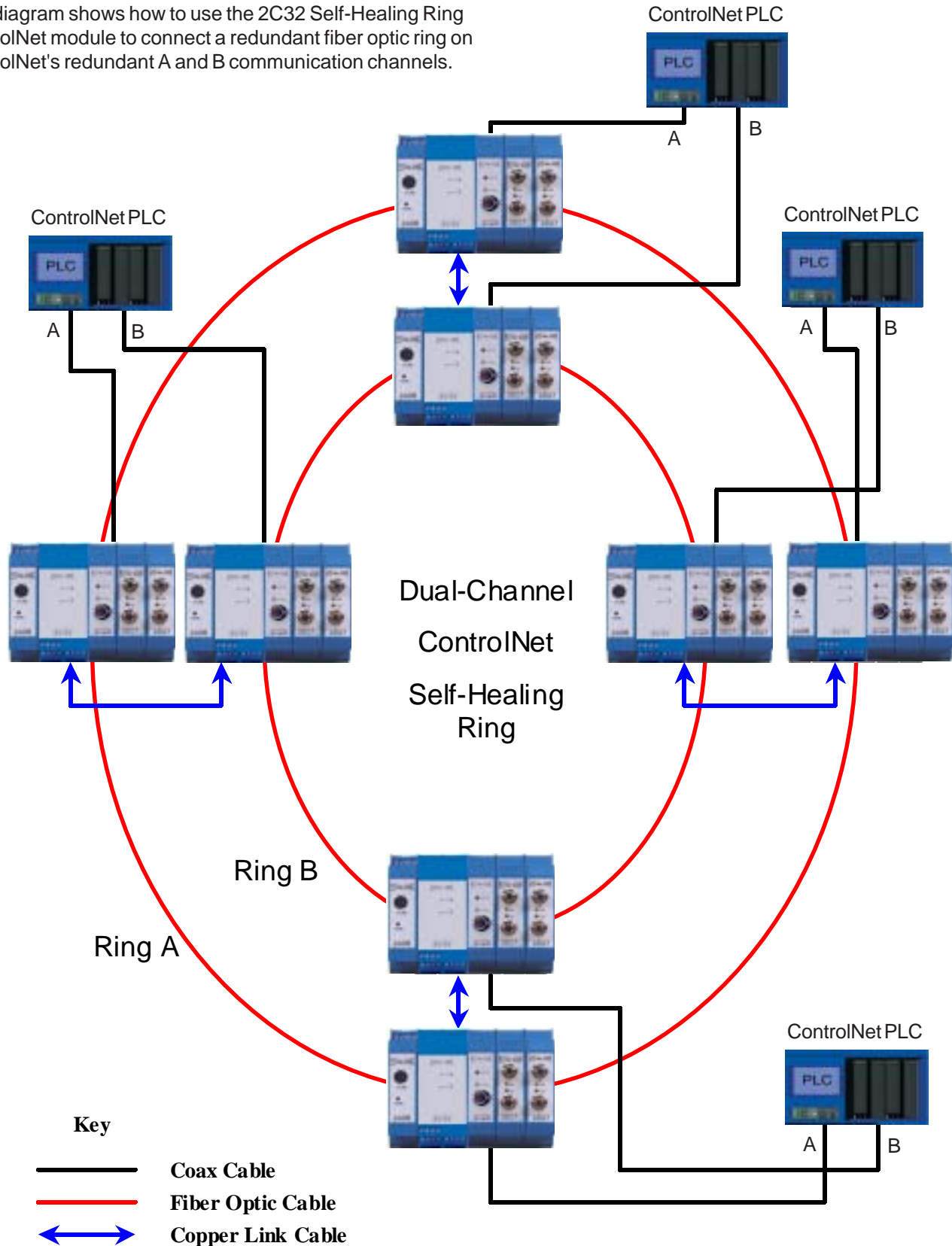

EOTec 2000 Fiber Optic Modems

Self-Healing Ring Module

A Self-Healing Ring (SHR) Module provides fiber media redundancy when utilized in each node or drop of a fiber optic ring-network. The SHR Module detects and redirects data to the secondary fiber path when a break in the fiber occurs between two adjacent nodes. The SHR automatically resets when the fiber path has been restored. Visible LED indicators in conjunction with relay contacts provide local and remote monitoring of the integrity of the fiber optic network.

The configuration of a Self-Healing Ring modem consists of a Power Supply, an Electrical Interface, a Self-Healing Ring Module and two Optical Interface Modules. Inter-module communications and operating power is achieved through the integrated module backplane connections.



ControlNet

ControlNet



Model Number	2C30	2C31	2C32	2C33
Description	SHR for PLC Networks (except ControlNet, Profibus and DeviceNet)	SHR for single channel ControlNet	SHR for dual channel ControlNet	SHR for Profibus
Communications Data Rate	9.6K to 2M Baud	5M Baud	5M Baud	All Profibus data rates
Certifications	FM Approved Class I Division 2, Groups A, B, C & D	Pending	Pending	Pending
Compatible Electrical Modules	2C02, 2C07, 2C10, 2C12, 2C14, 2C15, 2C29	2C20	2C20	2C22

Features of the 2C3x modules include:

- Independent of fiber optic cable size, communications protocol or baud rate
- Eliminates down time from fiber failure
- Fast network transparent fiber path switching
- System diagnostic indicators during operation
- Easy add-on upgrade to existing EOTec 2000 systems

Self Healing Ring Modules - Common Specifications

Status Indicator (Bi-color LED) Green: Functional Optic Link
Red: Loss of Optical Link
Relay Contact Rating: 175VDC, 0.25A Switching, 1A Continuous
Relay Connection: Pluggable Screw Terminal, 12 to 24 AWG(0.5-2.4mm) Cage-Clamp
Ambient Conditions: -40 to 95°C Operational, 0 to 90% Rel. Humidity Non-Condensing



EOTec 2000 Fiber Optic Modems

Self-Healing Ring Topology

The use of fiber optic technology to replace copper communications cable provides many advantages for industrial control applications. In addition to EMI/RFI immunity, the ability to run fiber optic cable through hazardous areas and long distances communication runs, another benefit is the ability to achieve media redundancy without incurring the cost of duplicate hardware systems. By using the Weed Instrument Self-Healing Ring solution, a critical system can achieve uninterrupted communications, even in the event of a failure in the fiber optic communication lines.

How it Works

The Weed **Patented** Self-Healing Ring Module (SHR) provides fiber media redundancy when utilized in each node or drop of a fiber optic ring-network. Data will always be routed on the shortest possible path to reduce propagation delay through the system. The SHR accomplishes this by creating a “virtual” break in the ring at the link farthest from the originating node. Please refer to the figure below. If Node 1 is the originating node of a message, a virtual break will be created on the fiber link C. If Node 2 is the originating node of a message, then a virtual link will be created on fiber link D. This virtual break is created on a packet by packet basis. The network therefore behaves as if it were in a Daisy Chain, preventing the delivery of the same packet to any node twice. When a real fiber break actually does occur, the SHR devices detect the break and a virtual break is no longer created since the real fiber break has done the function of putting the system into a Daisy Chain. The SHR automatically resets when the fiber path has been restored. Visible LED indicators in conjunction with relay contacts provide local and remote monitoring of the integrity of the fiber optic network.

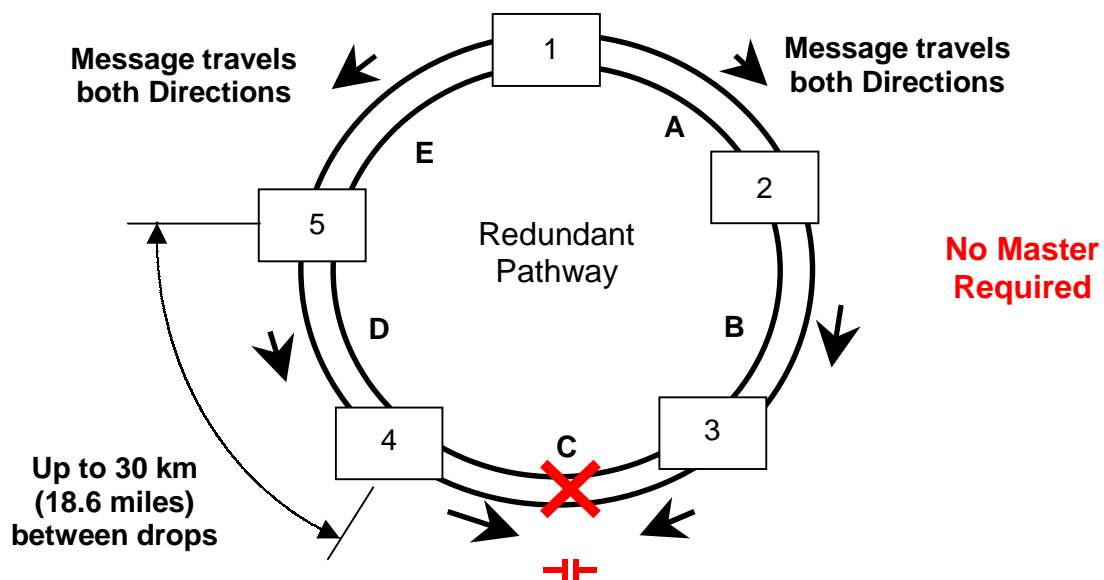

EOTec 2000 Fiber Optic Modems

Optical Interface Modules

Optical Interface Modules connect the EOTec 2000 modems to the fiber optic cable network, and transfer network data between nodes. Cascade different optical modules in a single modem assembly and optically link modems utilizing 850/1300nm optical wavelengths, Multi-mode or Single mode fiber, and SMA or ST* connectors. Two optical modules can be used in one modem to form an optical repeater or to configure an optical daisy chain. Up to five optical modules can be cascaded in one modem to establish an optical star network system. Two optical modules combined with a Self-Healing Ring module provide optical media redundancy in critical applications. A maximum combination of five optical or electrical modules may be connected together in one modem, inter-module communications and operating power is achieved through the integrated module backplane connections.

The basic modem configuration consists of a Power Supply Module, Electrical Interface Module, and an Optical Interface Module.

*ST is a trademark of AT&T



Model Number	2E06 / 2D06	2E07 / 2D07	2E10/2D10
Optical Wavelength	850nm	850nm	850nm
Optical Mode	Multi-mode	Multi-mode	Multi-mode
Communications Data Rate	9.6K to 12M Baud	9.6K to 12M Baud	9.6K to 12M Baud
Optical Port Connection	SMA Compatible	ST Compatible	ST Compatible
Optical Dynamic Range	21dB into 200/230µm	21dB into 200/230µm 12dB into 62.5/125µm	23db into 200/230µm 17dB into 62.5/125µm
Diagnostic Output 4-20 mA	2D06 only	2D07 only	2D10 only

Optical Interface Modules - Common Features

Ambient Conditions: -40 to 85°C Operational, 0 to 95% Rel. Humidity Non-Condensing

Emitter Type: LED

Power Requirement (Bus): 9VDC @ 200mA Max per module

Optical Transmit Indicator: Green LED

Optical Receive Indicator: Amber LED

Certifications: FM Approved Class I, Division 2, Groups A, B, C & D (selected models only)

Diagnostic Output (2Dxx): 4-20mA

IEC 60825-1 Class 1 LED Products, FDA 21CFR1040.10 & 1040.11

EOTec 2000 Fiber Optic Modems



2E09 / 2D09	2E19/2D19	2E36 / 2D36	2E46 / 2D46
1300nm	1300nm	1300nm	1300nm
Multi-mode	Multi-mode	Single Mode	Single Mode
9.6K to 12M Baud	9.6K to 12M Baud	9.6K to 12M Baud	9.6K to 12M Baud
ST Compatible	ST Compatible	ST Compatible	ST Compatible
12dB into 62.5/125µm	18dB into 62.5/125µm	10dB into 9/125µm	16dB into 9/125µm
2D09 only	2D19 only	2D36 only	2D46 only

2Dxx Optical Modules with 4-20mA Diagnostic Output (xx designates last two digits of Model Numbers)

2Dxx optical modules provide a full diagnostic output (4-20mA). The output is internally powered and is proportional to the received optical power. The output can be monitored and processed continuously in order to insure the integrity of the fiber optic link. This is beneficial for critical applications such as subsea networking where degradation of the optical signals can be detected before a complete loss of communication occurs. An output less than 4mA indicates loss of optical signal. A pluggable screw terminal connection on the bottom front of the module provides easy access to the output signal.

EOTec 2000 Fiber Optic Modems

Power Supply Modules

The EOTec Power Supply Modules supply operating power to the EOTec 2000 modules. Several different universal modules are available to conform to a wide variety of power sources typically found in industrial control panel applications where wall mounted power supplies are unacceptable. Mix and match to provide the option of "Hot-Swappable" dual power supplies with diagnostic outputs, eliminating "Single Point of Failure" locations in the network.

The basic modem configuration consists of a Power Supply Module, Electrical Interface Module, and an Optical Interface Module.



Approved
Class I, Division 2
Groups A, B, C & D



Model Number	2A06 / 2A16	2A08 / 2A18	2A56
Input Power Range	85 to 240VAC, 50/60Hz, 250mA 85 to 140VDC, 250mA	24 VDC \pm 20%, 400mA	85 to 240VAC, 50/60Hz, 250mA 85 to 140VDC, 250mA
Operating Power Output	Regulated, 9VDC 1.1A max	Regulated, 9VDC 1.1A max	Regulated, 24 VDC, 425mA max
Input Fuse Type	400 mA slow-blow	400 mA slow-blow	400 mA slow-blow
Compatibility	All bus powered modules	All bus powered modules	Fiber Optic Transmitter Fiber Optic Receiver (FOT/FOR)
Ambient Conditions	-40 to 85°C Operational 0-95% Rel. Humidity Non-Condensing	-40 to 85°C Operational 0-95% Rel. Humidity Non-Condensing	-40 to 85°C Operational 0-95% Rel. Humidity Non-Condensing
Diagnostic Output Form-C Relay	2A16 only	2A18 only	

Power Supplies with Diagnostic Alarm Relay Contacts

The 2A16 and 2A18 are power supplies with diagnostic alarm relay contacts accessible via screw terminals on the bottom front of the module. Relay Contact Ratings: Form-C, 175VDC, 1A continuous.

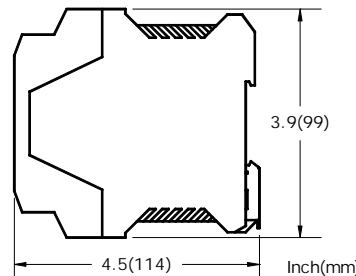
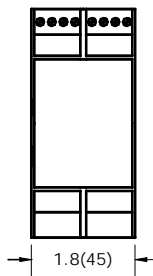

Mechanical Specifications

Double-width EOTec 2000 Modules - 2A06/2A16, 2A56 Power Supplies, 2C52/53 Ethernet Switches
Mounting: 35mm DIN Rail
Weight: <9oz (250g)



EOTec 2000 Fiber Optic Modems

EOTec 2000 Power Supply Selection Chart (xx designates last two digits of Model numbers)

Model #	Module Description	Power Supply
2C02	GE Genius Remote I/O	2A06/2A16 OR 2A08/2A18
2C07	Reliance R-Net Remote I/O	
2C10	RS-232/485	
2C12	Allen Bradley DH+ & Remote I/O	
2C14	Modicon Remote I/O	
2C15	Allen Bradley DH-485	
2C20	ControlNet	
2C21	DeviceNet	
2C22	Profibus - DP	
2C29	Modicon Modbus Plus	
2C30	Self-Healing Ring for PLC networks except ControlNet, DeviceNet, and Profibus	
2C31	Self-Healing Ring, 1-CH ControlNet	
2C32	Self-Healing Ring, 2-CH ControlNet	
2C33	Self-Healing Ring, Profibus	
2E06/2D06	Optical Module	
2E07/2D07	Optical Module	
2E09/2D09	Optical Module	
2E10/2D10	Optical Module	
2E19/2D19	Optical Module	
2E36/2D36	Optical Module	
2E46/2D46	Optical Module	
2E54	Switched Media Converter 10/100 Base-T	
2E56	Switched Media Converter 10/100 Base-T	
2E58	Switched Media Converter 10/100 Base-T	
2E60	Switched Media Converter 10/100 Base-T	
2C52	Ethernet Switch 10/100 Mbps	

The following modules can also be powered from a nominal 24VDC source via pluggable screw terminal blocks. They will then provide operating power to any bus interconnected modules.

2C23	Profibus w/Self-Healing Ring	2A06/2A16 OR 2A08/2A18	OR	External 24 VDC
2C53	Ethernet Switch 10/100 Base-T			
2E55	Switched Media Converter 10/100 Base-T			
2E57	Switched Media Converter 10/100 Base-T			
2E59	Switched Media Converter 10/100 Base-T			
2E61	Switched Media Converter 10/100 Base-T			
2Mxx	Multiplexer			
2Hxx/2Kxx	Multi-Channel CC/Output Module			
2Sxx/2Pxx	Multi-Channel CC/Input Module			
2Txx	FOT Analog Link	2A56	OR	External 24 VDC
2Rxx	FOR Analog Link			

EOTec 2000 Network Topologies

There are five basic network topologies possible with the EOTec 2000 system. Using these, many combinations can be created. Very similar topologies can be assembled with the other Weed Instrument fiber optic modems, the EOTec 6000.

Optical Repeater

Used for strengthening an EOTec optical signal that has traveled the maximum distance throughout a fiber optic cable. It is used for communicating over very long distances. In addition, this configuration can also convert multi-mode fiber to single mode, and vice versa.



Point-to-Point

Used to make simple connections from a PLC to a PLC or an I/O block.

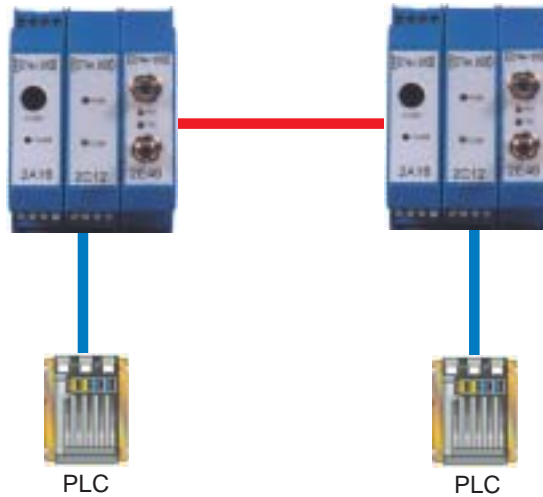

Daisy Chain

Used for multiple drops along a line.

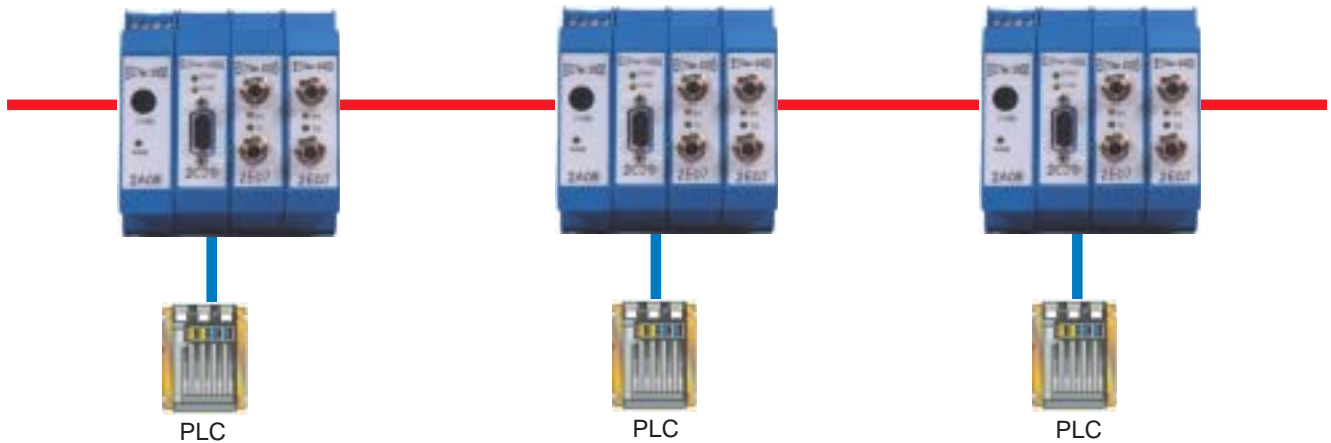

EOTec 2000 Network Topologies

Star Configuration

Used for branching from one point outward. As many as four branches can be made optically. A star system can be connected to another star system if more branches are required.

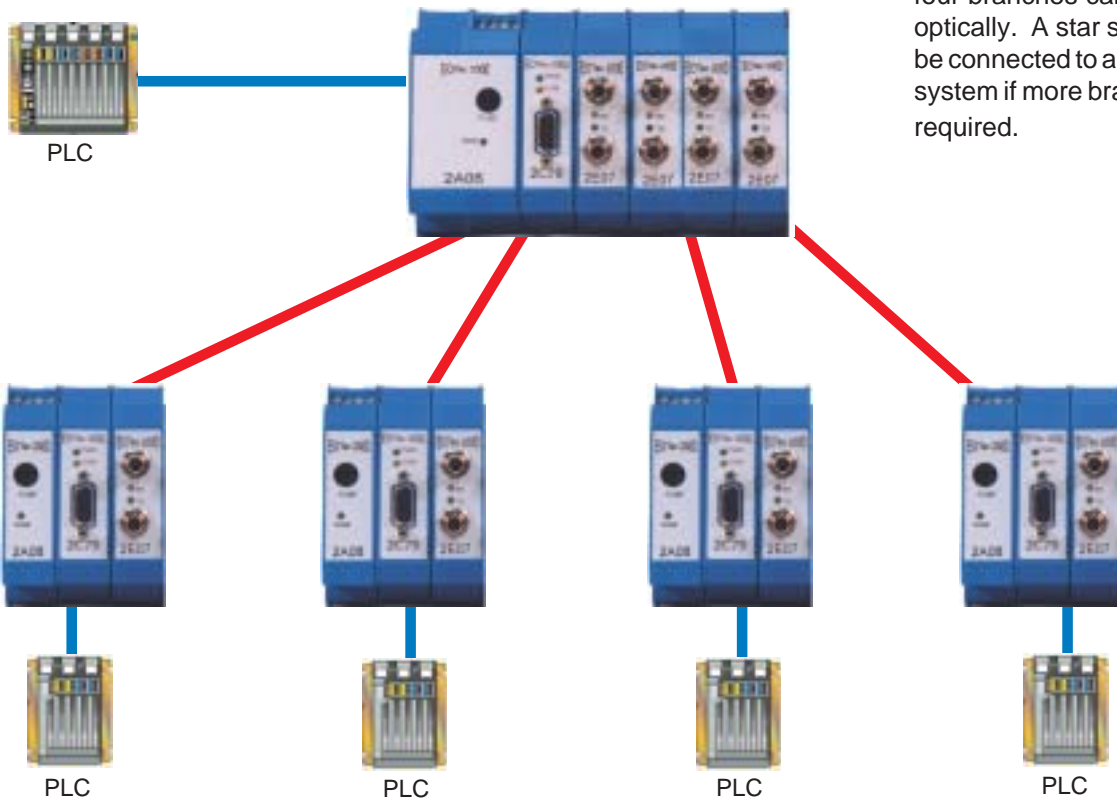

Self-Healing Ring

Provides fiber media redundancy.

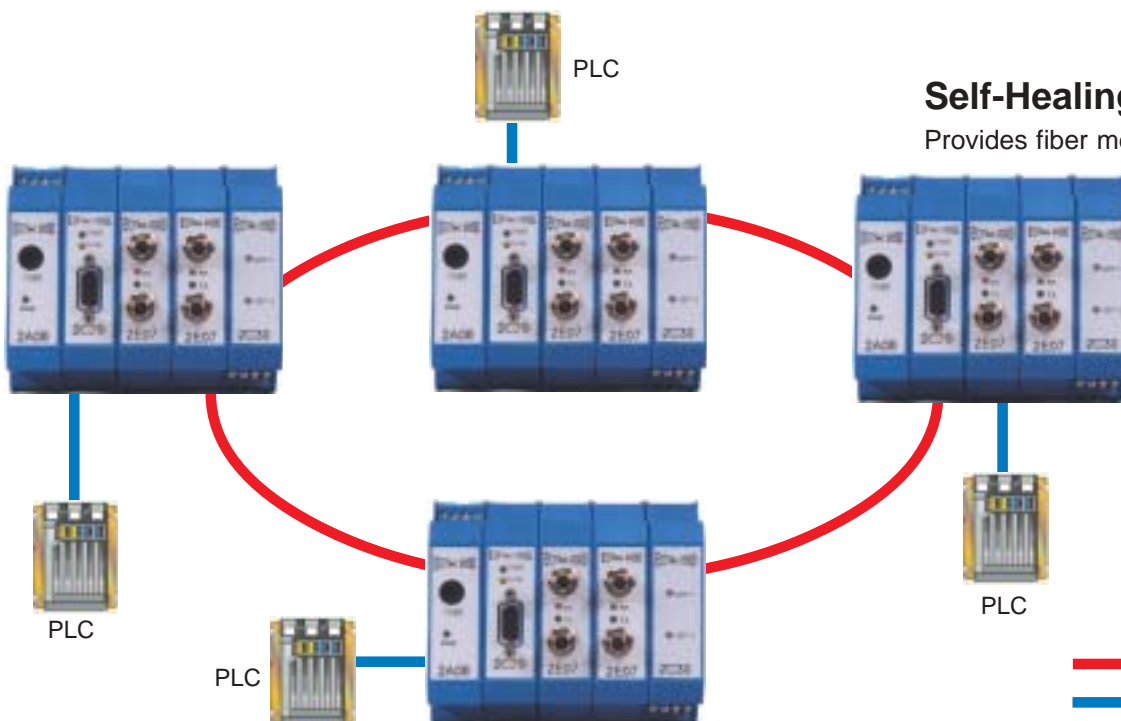

Key

-  -- Indicates fiber optic cable
-  -- Indicates copper cable

Fiber Optic Data Links

Analog Data Links

The modular EOTec 2000 fiber optic analog data link provides reliable EMI/RFI and lightning immune transmissions of 4-20mA and 0-10VDC signals over a single fiber optic cable. It is an ideal solution for long run cable problems and has a system accuracy of 0.1%. Each transceiver has a single optical port which can be configured for multi-mode or single mode fiber optic cable at 850 nm or 1300 nm using industrialized ST/SMA connectors. LED indicators are provided for Power, Over Range, Under Range and LOCK conditions. The fiber optic receiver (FOR) has additional outputs for signal LOCK and OVER RANGE conditions that can be used to light a remote warning, engage a relay or provide go/no-go information to computer control systems.

The FOT/FOR will accept power from an external 24VDC source connected directly to a pluggable screw terminal, or from a 120/240VAC power source when using the EOTec 2A56 Universal Power Supply (shown using both configurations in the photo). Optional external voltage (2M01) and current (2M02) meters are available for local monitoring of the input/output signals.

Applications for this device include long distance transmissions, lightning prone areas and transmissions through hazardous areas.



Model Number	Description*	Analog Signal	Wavelength	Optical Dynamic Range into 200/230 μm	Optical Dynamic Range into 62.5/125 μm	Optical Dynamic Range into 9/125 μm	Mating Receiver	Optical Mode	Fiber Connector
2T06	FOT	0-10VDC	850nm	37dB	N/A	N/A	2R06	MM	SMA
2T07	FOT	0-10VDC	850nm	37dB	25dB	N/A	2R07	MM	ST
2T09	FOT	0-10VDC	1300nm	37dB	25dB	N/A	2R09	MM	ST
2T10	FOT Hi-power	0-10VDC	850nm	43dB	31dB	N/A	2R07	MM	ST
2T12	FOT	4-20mA	850nm	37dB	N/A	N/A	2R12	MM	SMA
2T14	FOT	4-20mA	850nm	37dB	25dB	N/A	2R14	MM	ST
2T18	FOT	4-20mA	1300nm	37dB	25dB	N/A	2R18	MM	ST
2T20	FOT Hi-power	4-20mA	850nm	43dB	31dB	N/A	2R14	MM	ST
2T36	FOT	0-10VDC	1300nm	N/A	N/A	21dB	2R09	SM	ST
2T46	FOT Hi-power	0-10VDC	1300nm	N/A	N/A	29dB	2R09	SM	ST
2T72	FOT	4-20mA	1300nm	N/A	N/A	21dB	2R18	SM	ST
2T92	FOT Hi-power	4-20mA	1300nm	N/A	N/A	29dB	2R18	SM	ST
2R06	FOR	0-10VDC	850nm					MM	SMA
2R07	FOR	0-10VDC	850nm					MM	ST
2R09	FOR	0-10VDC	1300nm					MM/SM	ST
2R12	FOR	4-20mA	850nm					MM	SMA
2R14	FOR	4-20mA	850nm					MM	ST
2R18	FOR	4-20mA	1300nm					MM/SM	ST

* FOT: Fiber Optic Transmitter
FOR: Fiber Optic Receiver

Fiber Optic Data Links

Specifications – Analog Data Links

Power Requirements: 12 to 30VDC at 400mA, or 120/240VAC from 2A56 Power Supply

Input/Output Signals: 4-20mA or 0-10VDC

Wire Cable Connections: De-Pluggable, Cage-Clamp, Screw Terminal, accept 12 to 24 AWG

System Accuracy (FOT+FOR): $\pm 0.1\%$ of span typical

System Response Time (FOT+FOR): < 2 ms (10% to 90% input step change) transfer rates to 800Hz

Additional Outputs (FOR): OVER RANGE, analog signal supplied to transmitter is above normal input range

LOCK, turns on when FOR receives adequate light input from fiber

5-30VDC at 5mA, open collector

LED Indicators: Green - LOCK, receiving adequate optical signal strength from transmitter (FOR)

- PWR, power is applied to transmitter (FOT)

Amber - OVR, analog input signal at the mated transmitter is above 10VDC/20mA

- LOW, analog input signal is below 0VDC/4mA

Ambient Conditions: -40°C to 85°C Operational

0 to 95% Relative Humidity, Non-Condensing

Mounting: 35mm DIN-Rail

Weight/Unit: < 9oz (250g)

Housing Material: Plastic (UL94V-0)

Dimensions

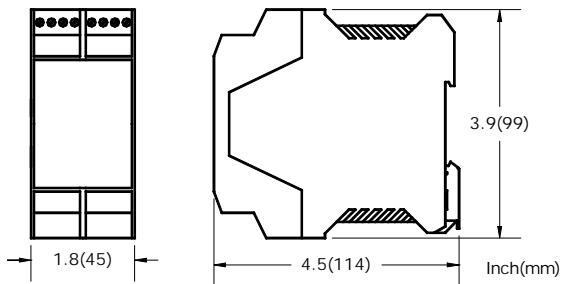

Accessories

2M01 Digital Volt Meter, 3 ½ Digit, 45mm housing

2M02 Digital Current Meter, 3 ½ Digit, 45mm housing

2A56 Power Supply, 85-240VAC, 50/60Hz or 85-125VDC

Features:

- No calibration required.
- Transmission of 4-20mA or 0-10VDC analog signals over a single fiber optic cable
- Configurable with multi-mode or single mode optical fiber
- Alarm outputs provided for signal LOCK and OVR (over range) conditions
- Available with dual redundant, hot swappable power supplies

Fiber Optic Analog Data Link - Application Diagram

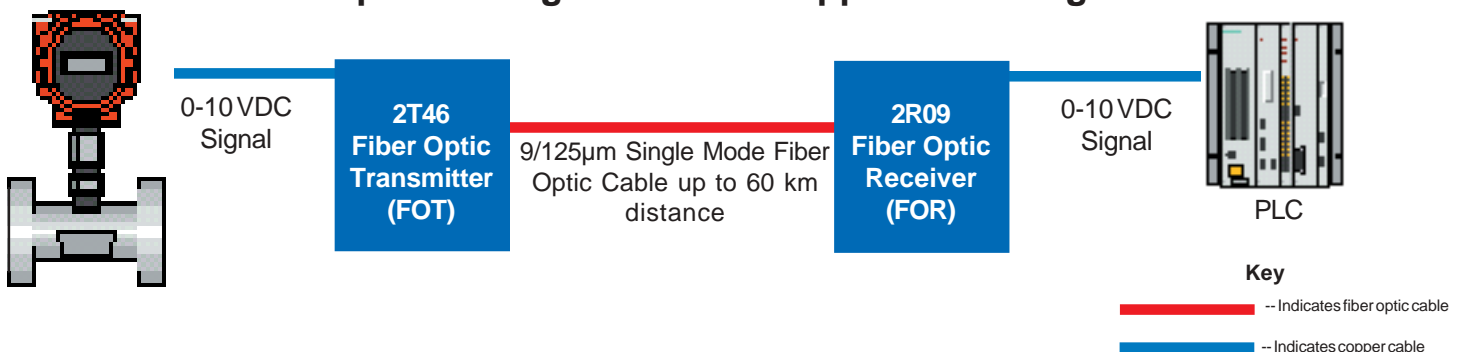

Fiber Optic Data Links

Multi-Channel Contact Closure

The EOTec 2000 fiber optic Multi-Channel Contact Closure modules are used to convert up to 10 contact closure inputs (switches, relays, etc.) into fiber optic signals for transmission over a single fiber optic link. Upon activation of the inputs, the receiver module receives the transmitted signals and de-energizes a corresponding, on-board relay operating in a fail-safe mode for switching critical systems.

Each transmit module includes two inputs and is capable of multiplexing up to 10 inputs by cascading additional dual channel input modules. An integrated backplane allows for communications between modules with no external inter-modular connection. Power to all modules is derived from any standard EOTec 2000 power supply through the integrated BUS connector or from an external 24VDC source supplied directly to the transceiver module.



Model Number	Description	Optical Dynamic Range	Input/Output Type	Fiber Connector
2S06	2-Channel, 850 nm, Multi-mode, Transmitter	12 dB	Dry Contact Input	SMA
2S07	2-Channel, 850 nm, Multi-mode, Transmitter	12 dB	Dry Contact Input	ST
2S09	2-Channel, 1300 nm, Multi-mode, Transmitter	12 dB	Dry Contact Input	ST
2S36	2-Channel, 1300 nm, Single mode, Transmitter	10 dB	Dry Contact Input	ST
2S46	2-Channel, 1300 nm, Single mode, Transmitter	16 dB	Dry Contact Input	ST
2H07	2-Channel, 850 nm, Multi-mode Receiver		Form C Relay Output	ST
2H09	2-Channel, 1300 nm, Receiver (Multi-mode or Single mode)		Form C Relay Output	ST
2P02	2-Channel Input Module		Dry Contact Input	N/A
2K02	2-Channel Output Module		Form C Relay Output	N/A

Specifications – Multi-Channel Contact Closure

Power Requirements:	7.5 VDC via the BUS interconnections (from any EOTec 2000 power supply module) or 12 to 30VDC @ 400mA, via a pluggable, screw terminal block on the 2Sxx/2Hxx module
Relay Contact Output:	SPDT Form C relay, via Pluggable Screw Terminal, 12 to 24 AWG(0.5-2.4mm) Cage-Clamp 60W, 125VA, maximum switching power 220VDC, 250VAC, maximum switching voltage 2A switching, 3A carry, maximum current 100,000,000 cycles, minimum operational life
Contact Closure Input:	External Dry contacts connected via pluggable, screw terminal blocks Accepts 12 to 24 AWG, 5VDC @ 1.4mA min. contact rating, 1K ohm max. resistance
LED Status Indicators:	Power On – Green, Ch. A Relay energized/input contact closed – Green, Ch. B Relay energized/contact input closed – Green, Fiber Transmit - Amber
Data Update Rate:	15mS regardless of the number of channels utilized
Ambient Conditions:	-40°C to 85°C Operational

Fiber Optic Data Links

Multi-Channel Contact Closure - Application Diagram

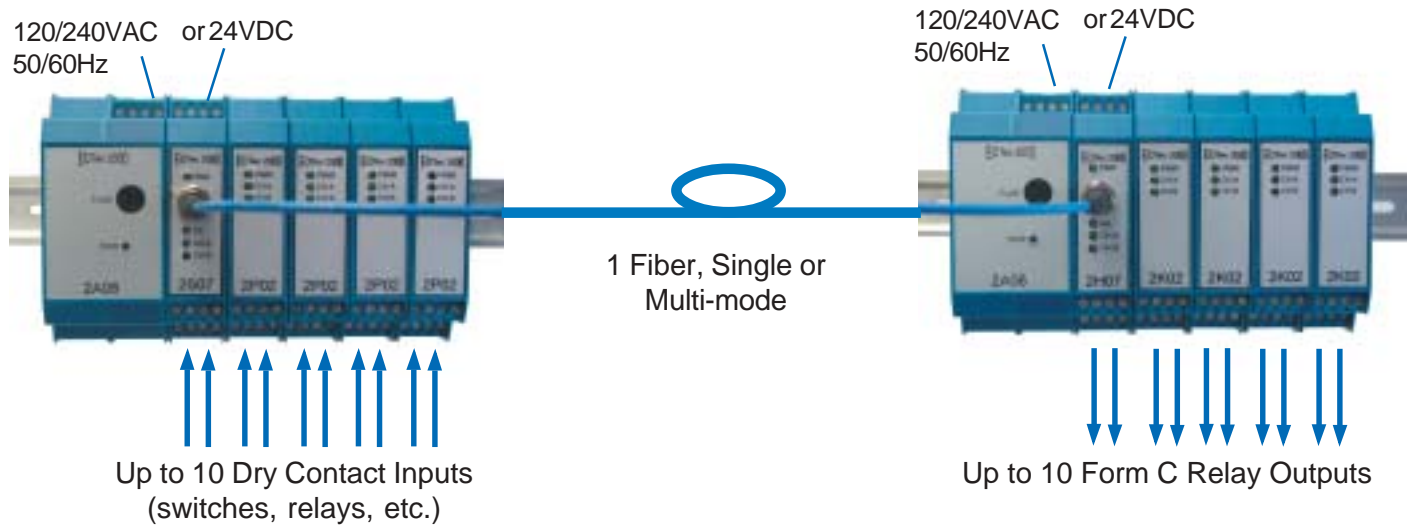

Features/Benefits:

- Modular design for transmitting 2 to 10 contact closure signals
- Fail-safe operation
- Electrical isolation
- Reliable EMI, RFI free communications
- Cost-effective, low maintenance installation
- Available with dual redundant, hot swappable power supplies
- Designed for mounting on standard 35 mm DIN-Rail

Applications:

- Safety shutdown systems
- Remote transmission over long distances (up to 16 miles)
- Transmission through hazardous areas
- Alarm event triggering

Fiber Optic Multiplexer

Multi-Channel Analog/Digital Multiplexer

The EOTec 2000 Multiplexer can be used to send up to eight channels of bi-directional electrical information over a pair of fiber optic cables. A selection of input/output modules such as 4-20mA, 0-10VDC, contact closure or RS-232/485 is available for flexible system configurations.

The base unit (or brain) connects to the fiber optic cable and provides visual indication of fiber link status. Each base unit has a duplex optical port configured for use with 850nm or 1300nm, multi-mode or single mode optical fiber. An integrated backplane allows for communications from the base unit to the input/output modules with no external inter-modular connection. No programming is needed.

Power is supplied either through the standard EOTec 2000 power supplies or from an external 24VDC power supply. The typical multiplexer consists of the base unit, power supply and selected input/output modules

Applications include remote analog data acquisition; smoke stack instrumentation and lightning immune extension of DCS or PLC systems.



Base Units

Model Number	Description	Optical Dynamic Range	Optical Mode	Optical Connector	Optical Fiber Size
2M55	Multiplexer, Base Unit, 1300nm	9 dB	Multi-mode	ST	50 – 100µm
2M57	Multiplexer, Base Unit, 1300nm	9 dB	Multi-mode	SC	50 – 100µm
2M59	Multiplexer, Base Unit, 1300nm	16 dB	Single Mode	SC	5 – 10µm
2M61	Multiplexer, Base Unit, 1300nm	36 dB	Single Mode	SC	5 – 10µm

Input/Output Modules

Model Number	Description	Input/Output Type	Baud Rate
2M11	2-CH Input Module	0-10 VDC	N/A
2M21	2-CH Output Module	0-10 VDC	N/A
2M12	2-CH Input Module	4-20 mA	N/A
2M22	2-CH Output Module	4-20 mA	N/A
2M13	2-CH Input Module	Dry Contact (1KΩ max/5VDC)	N/A
2M23	2-CH Output Module	Form C Relay (2A 220VDC, 250VAC)	N/A
2M30	2-CH Bi-directional Module	RS-232/485	9.6K to 115K

Fiber Optic Multiplexer

Fiber Optic Multiplexer - Application Diagram

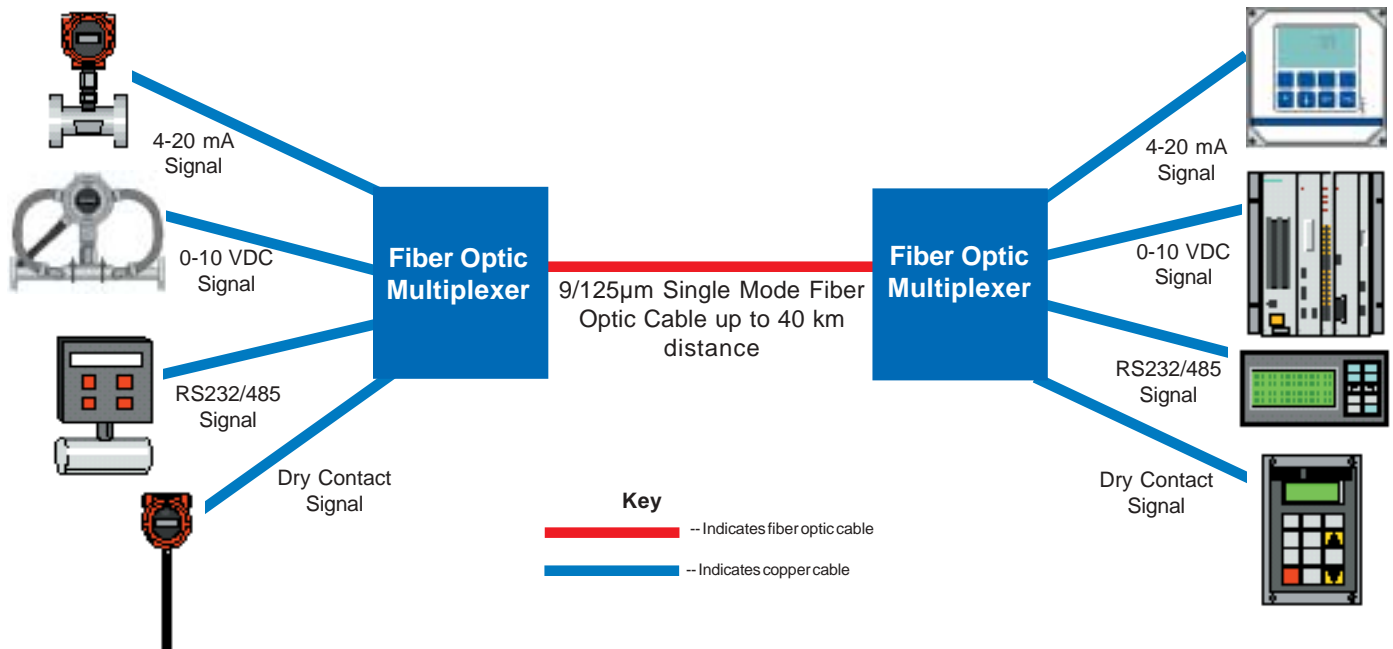

Features/Benefits:

- Transmits up to 8 analog or digital signals over a pair of fiber optic cables
- Bi-directional communications
- Configurable with multi-mode or single mode optical fiber
- Pluggable screw terminals for all wire connections
- Visible status LED's for power, TX/RX and channel inputs
- Available with dual redundant, hot swappable power supplies
- Designed for mounting on standard 35 mm DIN rail
- Dimensions (each module): 22.5 mm (0.9") w x 99 mm (3.9") h x 114 mm (4.5") d

Specifications – Multiplexer Input/Output Modules

Power Requirements: 7.5 VDC via the BUS interconnections (from 2A06/16 or 2A08/18 power supply module) or from an external 24VDC 400mA max) source, via a pluggable screw terminal block on base unit

Copper Connection: Pluggable screw terminal, 12 to 24 AWG (0.5 - 2.4mm) cage clamp

LED Status Indicators: Power On – Green,
 Ch. A, Ch. B activity - Green,
 Multiplexer status - Bi-color - Red/Green - Bad/Good

Data Update Rate: <20µS regardless of the number of channels utilized

Ambient Conditions: -40 to 85°C Operational, 0-95% RH (Non-condensing)

EOTec 2000 Ethernet Connectivity

Industrial Ethernet Switched Media Converters

The EOTec 2E54-2E61 Switched Media Converters provide fiber optic conversion to and from wire based Ethernet. The fiber ports operate at 100Mbps, Full Duplex. The RJ45 ports will auto-negotiate data rates between 10/100 Mbps and Full/Half Duplex operation. These modules will automatically learn the addresses of the devices connected to each port (up to 1024) and will buffer and route messages accordingly. There is an additional Ethernet port in the module's integrated BUS, which provides connection for one additional EOTec 2000 Ethernet Switch or Switched Media Converter Module, assisting in forming Star or Daisy Chain network configurations.



Model Number	2E54 / 2E55	2E56 / 2E57	2E58 / 2E59	2E60/2E61
Description	Switched Media Converter 10/100Mbps	Switched Media Converter 10/100Mbps	Switched Media Converter 10/100Mbps	Switched Media Converter 10/100Mbps
Power Requirement	2E54: Bus powered from 2A06/16 or 2A08/18 2E55: External, 10-30VDC@200mA	2E56: Bus powered from 2A06/16 or 2A08/18 2E57: External, 10-30VDC@200mA	2E58: Bus powered from 2A06/16 or 2A08/18 2E59: External 10-30VDC@200mA	2E60: Bus powered from 2A06/16 or 2A08/18 2E61: External 10-30VDC@200mA
Optical Data Rate	100Mbps, Full duplex	100Mbps, Full duplex	100Mbps, Full duplex	100Mbps, Full duplex
Optical Wavelength	1300nm	1300nm	1300nm	1300nm
Optical Mode	Multi-mode	Multi-mode	Single mode	Single mode
Optical Connectors	ST Compatible	SC Compatible	SC Compatible	SC Compatible
Optical Fiber Size	50 - 100µm core diameter	50 - 100µm core diameter	5 - 10µm core diameter	5-10µm core diameter
Optical Dynamic Range	9dB	9dB	16dB	36dB

Common Features: 2E54 - 2E59

Ethernet Compliance: IEEE 802.3 (U)(X) Compliant, All standard protocols

RJ45 Port Data Rate: 10 or 100Mbps (10/100Base-T(X)), Full or Half Duplex, Automatic wiring correction

Power Indicator: Green LED - On when proper power is connected

Data Indicator: Green LED - OFF when no connection is detected on port; ON when connection to port established; FLASHING to indicate activity on port

Port Speed Indicator: Amber LED - OFF when data rate is 10Mbps; ON when data rate is 100Mbps

Ambient Conditions: -40 to 85°C Operational, 5 to 95% Relative Humidity, Non-Condensing

Certifications: FM Approved for Class I Division 2, Groups A, B, C & D (most models)



EOTec 2000 Ethernet Connectivity

Industrial Ethernet Switch

EOTec 2000 Ethernet Switch is an industrially-hardened, DIN-Rail mountable device, which allows you to extend your industrial Ethernet network.

The 2C52 and 2C53 10/100BASE-T Ethernet Switches have four RJ45 twisted pair ports and one BUS port. The integrated BUS port provides a connection for one additional EOTec 2000 Ethernet Switch or Switched Media Converter assisting in forming star network configurations. Ethernet switches are unmanaged and require no user configuration. The data rate is automatically negotiated and the ports will auto-sense full or half duplex operation. The switches will automatically learn the addresses of the devices connected to each port and will buffer and route messages accordingly.



FM Approved for Class I
Division 2, Groups
A, B, C & D

Ethernet Modules are
Configurable to Multiple
Interconnects



Two 2E55 Switched
Media converters



2E55 Switched Media converter
with a 2C53 Ethernet Switch



Two 2C53 Ethernet Switches

Model Number	2C52 / 2C53
Description	Ethernet Switch 4 RJ45 ports 1 bus port
Power Requirements	2C52: Bus powered from 2A06/16 or 2A08/18 2C53: External 10-30VDC @180mA
Communications Data	10/100 Base-T Full or Half Duplex
Ethernet Compliance	IEEE 802.3 (U)(X) Compliant, All standard protocols
Port Activity Indicators	Green LED: Off when no connection is detected on port, On when connection to port established, Flashing to indicate activity on port
Port Speed (RJ45) Indicator	Amber LED: Off when data rate is 10Mbps, On when data rate is 100Mbps
Ambient Conditions	-40 to 85°C Operational 5 to 95% RH, Non-Condensing



Ethernet Connectivity

Managed Fast Ethernet Redundant Ring Switch

The R208 Managed Ring Switch is the ideal solution for redundant systems. The Fast Re-configuration of Networks Topology (FRNT) concept of Weed Instrument offers ultra fast ring re-configuration (30ms) of the network topology and both fault contact and SNMP to provide notification of the ring failure.

The FRNT concept eliminates failures caused by network links and/or switches. Redundancy can be achieved for most types of network topologies, such as Single Ring, Double Rings and Bridged Rings (redundant connections between two rings). A redundant ring topology is a good choice when high availability is needed and when ultra fast re-configuring in case of ring failures is a must. Recovery time of the Redundant Ring is as fast as 30 ms, and network load generated by ring packets is kept on a very low level. The ring is managed by one of the switches (user configured), referred to as the Focal Point (the Root Switch). The other switches in the ring are called member switches.

Configuration of the switches is easy and is done by the user in the Windows based IP Configuration tool. Any of the Ethernet ports can be used. Thus, no serial port is



R208F2-MM-ST-2-W

required for setting the IP address or any other configuration parameter on the R208 switch. This means that the R208 can be mounted and installed prior to configuration. Remote configuration and supervision through the network is also possible using the same tool. Communication with the switch itself can also be done by SNMP, and a private MIB is supplied on request, reading inside temperature, HW version, serial number, etc.

Standard Models	Description	Local 10/100 TX Ports (RJ45)	Ring Ports
R208F2-MM-ST-2-W	Managed 10/100Mbps Ethernet Ring Switch 6-port RJ45, 2-port fiber, 850 nm, MM, ST	6	2 - 100 FX Multi-mode, ST
R208F2-SM-SC-15-W	Managed 10/100Mbps Ethernet Ring Switch 6-port RJ45, 2-port fiber, 1300 nm, SM, SC	6	2 - 100 FX Single mode, SC
R208-W	Managed 10/100Mbps Ethernet Ring Switch 8-port RJ45	6	2 - 10/100 TX (RJ45)

Variants:

U/R/T207F1: 6 TX + 1 FX (MM or SM): MTRJ, LC, SC, ST
 U/R/T208F2: 6 TX + 2 FX (MM or SM): MTRJ, LC, SC, ST
 U/R/T208F3: 5 TX + 3 FX (MM or SM): MTRJ, LC
 U/R/T208F4: 4 TX + 4 FX (MM or SM): MTRJ, LC
 U/R/T208F5: 3 TX + 5 FX (MM or SM): MTRJ, LC
 U/R/T208F6: 2 TX + 6 FX (MM or SM): MTRJ, LC
 U/R/T208F7: 1 TX + 7 FX (MM or SM): MTRJ, LC
 U/R/T208F8: 8 FX (MM or SM): MTRJ, LC

Part Number Descriptions:

U208 - Series 200 Unmanaged Switch, eight ports
 R208 - Series 200 Ring Switch, eight ports
 T208 - Series 200 Time Sync. Switch, eight ports
 F2 - 2 Fiber Ports
 MM - Multi-mode
 SM - Single Mode
 ST - ST style connectors for fiber ports
 SC - SC style connectors for fiber ports
 2 - 2km distance between nodes
 15 - 15km distance between nodes
 W - Weed Instrument

Ethernet Connectivity

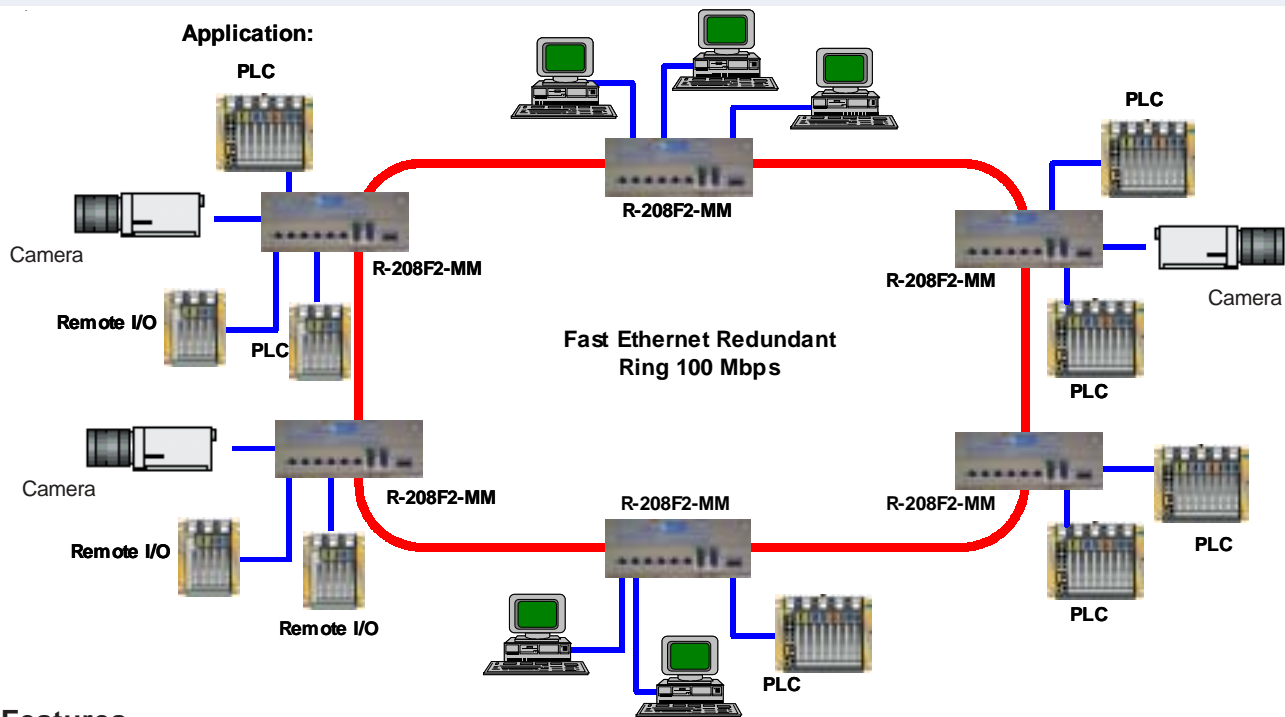

Features

- Free Windows based configuration tool, IPConfig
- Real time Ethernet:
 - QoS based on layer 2 (IEEE802.1p) and layer 3 (IP ToS)
 - Strict priority scheduling
 - Head of Line blocking prevention for low priority packets
- FRNT:
 - 30ms reconfiguration of redundant ring topology based on the Fast Re-configuration of Network Topology (FRNT) protocol
 - Up to 200 switches supported in Ring
 - Most network topologies are supported
- IGMP snooping
 - Fully automatic, no separate IGMP server (router) required
 - Multicast stop filter option
 - Integration with FRNT for fast multicast filter update in case of topology changes.
- SNMP
- DHCP
- IP gateway support
- True industrial specification
 - Military Design
 - Wide temperature range (-40 to +85°C)
 - Wide DC power range (19 to 60VDC)
 - No moving parts or electrolytic capacitors
 - Low power consumption (typically 8-16 W depending on fiber options)
 - Redundant power inputs
 - High MTBF numbers
- MDX/MDIX technology to ease switch connection
- User configurable fault contact
- Push buttons for port configuration (auto-neg HDX/FDX and 10/100 Mbps)
- 35mm DIN-Rail mounting
- 19" rack mounting and wall mounting options
- Options:
 - VLAN support according IEEE802.1D
 - Security vs. MAC attacks
 - RSTP and STP

Specifications

Input Power: 19 - 60 VDC
Power Consumption (Typ): R208:6W, R208F2-MM: 8W, R208F2-SM: 8W
Power Consumption (Max): R208:8W, R208F2-MM: 10W, R208F2-SM: 10W
Isolation: 1500 VDC
Ambient Conditions: -40 to 85°C Operational, 5 to 95% Rel. Humidity Non-Condensing
Enclosure: IP-40 (Dust Proof)
Altitude: to 2000m
EMC: EN 61000-6-2 industrial immunity, EN 50081-2 industrial emission,
Vibration: IEC 255-21-1 and -2, Class 1
Safety: EN60950
Dimensions: (WxHxD) 217mm (8.5") x 88mm (3.5") x 124mm (4.9")
Weight: 1550g (3.4 lbs)

EOTec 6000 Fiber Optic Modems

Overview

In 1993 Weed Instrument acquired from 3M Corporation the manufacturing/marketing rights to the EOTec line of industrial communications products. Since then, the EOTec 6000 line has been expanded and improved to provide communications with all major brands of PLCs. Applications include industrial process control systems requiring communications between components of the system that may span thousands of feet. Control of the processes may be extremely critical and require highly reliable communications links.



The EOTec 6000 Modular Fiber Optic Modem offers reliable data communication in plant automation systems. This modem has a modular format that offers easy configurability for specific plant networking requirements. Fiber optic modems provide total electrical isolation, eliminating problems with EMI/RFI, lightning, long distances, crosstalk and ground noise. The EOTec 6000 offers greater flexibility and overall cost savings due to its modular, rugged design and proven technology.

The modular modem consists of four basic components: the rack; electrical interface card; optical interface card; and power supply. The EOTec 6000's flexible modular design allows configuration of the electrical and optical modules for the most cost effective solutions to your industrial communication needs. Each of the basic modules are sold separately. See individual data sheets for more detailed specifications.

PLC Compatibility:

- ALLEN-BRADLEY
- MODICON
- GE FANUC
- TI/SIEMENS
- SQUARE D
- WESTINGHOUSE
- RELIANCE
- RS 232/422/485

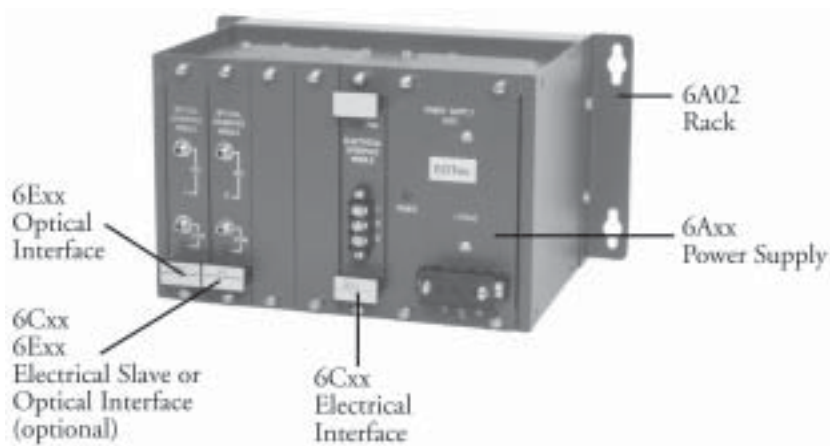

EOTec 6000 Fiber Optic Modems

Power Supplies/Racks

Module # - Description
6A01 - Power Supply (115 VAC input)
6A02 - Modular Rack
6A03 - Power Supply (220 VAC input)
6A04 - Blank panel for unpopulated rack slots
6A05 - Power Supply (90 to 165 VDC input)
6A06 - Power Supply (110/220 VAC input) UL Approved
6A08 - Power Supply (24 VDC)
6A09 - Heavy duty bracket
6A10 - Bracket for 19" Rack Mount
6A18 - Redundant Power Supply (24 VDC input)
6A28 - Dual 6A18 Housing

Power supply modules are available with various input capabilities, as well as a dual redundant power supply. The rack holds the electrical, optical and power supply modules. Each rack can hold one power supply, one electrical interface module and one to four optical or additional electrical interface modules.



Self-Healing Ring

The EOTec Series 6000 Self-Healing Fiber Optic Modem system provides fault tolerant reliable data communications for plant automation systems. Utilizing the 6C30/6C31 Master/Slave Modules in a ring configuration provides for a modular format that is easily configurable for your specific needs.



Electrical Interfaces

Module # - Description
6C01 - Modicon Remote I/O Compatible, BNC connector
6C02 - GE Fanuc Genius™ I/O Compatible
6C03 - Square D SY/NET™ Compatible
6C04 - Westinghouse HPPC™ Compatible
6C05 - TI Tiway™ Compatible
6C06 - TI 560/565 I/O Compatible
6C07 - Reliance R-Net™ & I/O Compatible
6C09 - Modicon ModbusPlus™
6C10 - RS 232/422 Compatible
6C11 - Modicon Remote I/O Self-Healing Ring Module
6C12 - Allen Bradley DH+ and I/O Compatible
6C14 - Modicon Remote I/O Compatible, F connector
6C15 - Allen Bradley DH-485 Compatible
6C16 - RS-485, DB-9 Connector
6C17 - RS-485, F Connector
6C29 - Modicon Modbus Plus™ Compatible ModConnect® certified
6C30 - Self-Healing Ring Master Module
6C31 - Self-Healing Ring Slave Module

"SY/NET" is a trademark of Square D. "TI Tiway" is a trademark of Texas Instruments. "Westinghouse HPPC" is a trademark of Westinghouse. "Reliance R-Net" is a trademark of Reliance Electric Company.*

EOTec 6000 Fiber Optic Modems

Optical Interfaces

The optical interface module (OIM) connects the EOTec 6000 Modem with the fiber cable system allowing the optical signal to be transmitted to and received from another fiber optic modem. A second optical module can be added to the modem for daisy-chain functions. Up to four OIMs together with any EIM can be configured into a modem to function as an optical star coupler.



The exclusive 6E21 Ping-Pong optical module provides bi-directional communications on a single fiber cable.

Module # and Power Specifications							
Optical Module	Optical Connectivity	Wavelength	Optical Mode	Baud Rate	Optical Dynamic Range 200/230 μm	Optical Dynamic Range 62.5/125 μm	Optical Dynamic Range 9/125 μm
6E01	SMA	850nm	Multi-mode	9.6K-500K	17dB	N/A	N/A
6E02	SMA	850nm	Multi-mode	9.6K-500K	23dB	N/A	N/A
6E03	ST	850nm	Multi-mode	9.6K-500K	17dB	12dB	N/A
6E04	ST	850nm	Multi-mode	9.6K-500K	23dB	17dB	N/A
6E05	ST	1300nm	Multi-mode	9.6K-500K	N/A	12dB	N/A
6E06	SMA	850nm	Multi-mode	500K-2M	17dB	N/A	N/A
6E07	ST	850nm	Multi-mode	500K-2M	17dB	12dB	N/A
6E08	SMA	850nm	Multi-mode	500K-2M	23dB	N/A	N/A
6E09	ST	1300nm	Multi-mode	500K-2M	N/A	12dB	N/A
6E10	ST	850nm	Multi-mode	500K-2M	23dB	17dB	N/A
6E21	ST	850nm	Multi-mode	9.6K-2M	N/A	5dB	N/A
6E31	ST	1300nm	Single Mode	9.6K-500K	N/A	N/A	10dB
6E36	ST	1300nm	Single Mode	500K-2M	N/A	N/A	10dB
6E41	ST	1300nm	Single Mode	9.6K-500K	N/A	N/A	16dB
6E46	ST	1300nm	Single Mode	500K-2M	N/A	N/A	16dB

EOTec 6000 Fiber Optic Modems

EOTec 6000 Optical Interface Selection Chart

		Multi-Mode										Single Mode					
		9.6K-500K Baud					500K-2M Baud					9.6K-500K		500K-2M			
Electrical Interface		Optical Interface	6E01	6E02	6E03	6E04	6E05	6E06	6E07	6E08	6E09	6E10	6E21	6E31	6E41	6E36	6E46
6C01	Modicon Remote I/O BNC Connector							X	X	X	X	X	X			X	X
6C02	GE Fanuc Genius I/O	X	X	X	X	X								X	X		
6C03	Square D SY/NET	X	X	X	X	X								X	X		
6C04	Westinghouse HPPC							X	X	X	X	X	X			X	X
6C05	TI Tiway	X	X	X	X	X								X	X		
6C06	TI 560/565 I/O							X	X	X	X	X	X			X	X
6C07	Reliance R-Net & I/O							X	X	X	X	X	X			X	X
6C09	Modicon Modbus Plus							X	X	X	X	X	X			X	X
6C10	RS 232/422	X	X	X	X	X								X	X		
6C12	Allen Bradley DH+ & Remote I/O	X	X	X	X	X								X	X		
6C14	Modicon Remote I/O F Connector							X	X	X	X	X	X			X	X
6C15	Allen Bradley SLC 500	X	X	X	X	X								X	X		
6C16	RS 485 DB-9 Connector	X	X	X	X	X								X	X		
6C17	RS 485 F-Connector							X	X	X	X	X	X			X	X
6C29	Modicon Modbus Plus							X	X	X	X	X	X			X	X

SMA Connector	X	X					X		X								
ST Connector			X	X	X			X		X	X	X	X	X	X	X	X

Power Budget (dB) 200/230 Micron 850nm	17	23	17	23	N/A	17	17	23	N/A	23	N/A	N/A	N/A	N/A	N/A	N/A
Power Budget (dB) 62.5/125 Micron 850nm	N/A	N/A	12	17	N/A	N/A	12	N/A	N/A	17	5	N/A	N/A	N/A	N/A	N/A
Power Budget (dB) 62.5/125 Micron 1300nm	N/A	N/A	N/A	N/A	12	N/A	N/A	N/A	12	N/A	N/A	N/A	N/A	N/A	N/A	N/A
Power Budget (dB) 9/125 Micron 1300nm	N/A	N/A	N/A	N/A	N/A	N/A	N/A	N/A	N/A	N/A	N/A	10	16	10	16	

Fiber Optic Data Links

Digital Data Links - Contact Closure

The FOT-CC and FOR-CC Fiber Optic Transmitter/Receiver can be used to transmit contact closure data over long distances. DIN-Rail mount housings enable easy mounting on industry standard hardware. The FOT-CC Transmitter provides a closed contact signal to the FOR-CC Receiver, which activates a Single Pole Double Throw (SPDT) relay. These devices can be used with 50/125 to 200/230 μm fiber optic cable and provide ground loop isolation.



Model Number	Description	Input/Output	Optical Connector
FOT-CC	Transmitter	Dry Contact Input	ST
FOR-CC	Receiver	Form-C Relay Output	ST
PSM-CC	Power Supply	100-250VAC Input 24VDC @ 200mA Output	Screw Terminal

Features:

- Transmissions up to 5000 meters (16,400 ft)
- 50/125-200/230 μm fiber optic cable
- ST Fiber Connection
- Ground Loop Isolation
- Fail Safe Operation
- DIN - Rail Mount

Specifications - Digital Links

Power: 24VDC @ 50 mA

Optical Dynamic Range: 30dB into 200/230 μm fiber, 18dB into 62.5/125 μm fiber

Optical Wavelength: 850nm multi-mode (standard), 1300nm multi-mode and single mode (optional)

Relay Contact Rating (FOR-CC): Maximum Switching Voltage 100VDC, 250VAC, 5A @ 30VDC, 10A @ 125VAC, 6A @ 277VAC (Resistive Load)

Connections: Cage-Clamp screw terminals, 12 - 24 AWG (0.5-2.4mm)

Indicators: Green LED - Power, Closed Contacts

Input (FOT-CC): Dry contacts, 10 ohms max. contact resistance

Ambient Conditions: -40 to 85°C Operational, 0 - 95% Rel. Humidity, Non-condensing

Fiber Optic Data Links

FOT/FOR - CC Application Diagram

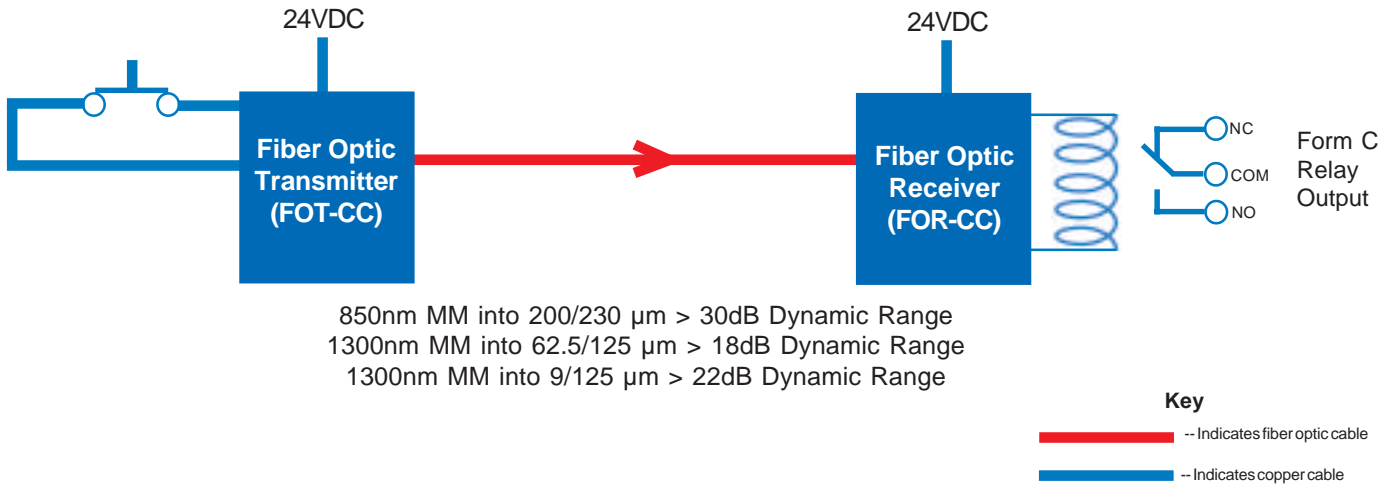

FOT-CC/FOR-CC Single-Channel Version

The following chart indicates how the output relay contacts will operate on the FOR-CC provided the input contacts on the FOT-CC are wired in a fail-safe mode (i.e. input contacts closed in a normal state):

Fail-Safe Operation

Condition	FOR-CC Output Relay
1. Normal condition, input closed	Energized
2. Normal condition, input open	De-energized
3. Loss of power at TX	De-energized
4. Loss of power at RX	De-energized
5. Fiber loss (or disconnected)	De-energized
6. Component failure at TX	De-energized
7. Component failure at RX	De-energized

OEM Customers

- ABB/Westinghouse
- GE Nuclear
- Siemens

Accessories & Service



Termination Kits

Termination kits are available for 200/230 μ m fiber sizes for SMA and ST connectors. The kits are easy to use by plant personnel and do not require epoxy or polishing, thus providing cost-effective installation. Fiber optic jumpers and connectors can also be supplied. These assemblies are extremely rugged to survive harsh plant conditions.



Test Equipment

A comprehensive range of specialized fiber optic test equipment is available for either purchase or rental. This equipment includes Optical Time Domain Reflectometers (OTDR), battery-powered Optical Power Meters, light sources, and accessories. Training and on-site support services are available for learning how to use the equipment and for developing customized maintenance and troubleshooting programs.

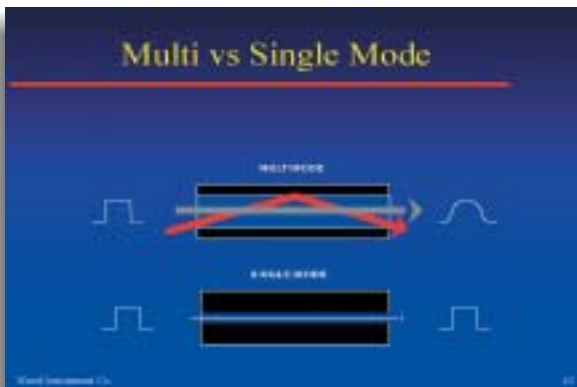

Training Seminars

Weed Fiber Optics provides both on-site training programs as well as comprehensive public seminars on topics ranging from the basics of fiber optic theory and system design to hands-on fiber termination and cable installation training. Training sessions can run from two hours to three days and can be custom designed to meet your specific needs. Training is focused on Instrumentation and Control applications, and is taught by Weed's experienced staff.

Services

Custom Engineering

Weed Instrument design engineers are experts in the fields of fiber optics, multiplexing, signal conditioning, and industrial control system design. If equipment is needed beyond our standard product lines, custom designs or modifications can be provided. The staff also has immediate access to other Weed Instrument experts in temperature and pressure sensing equipment and applications.



Field Support

Highly experienced technicians and engineers are available to assist in the installation, start-up, maintenance, and troubleshooting of fiber optic systems. They have extensive experience in many types of industrial manufacturing plants and power facility applications and are available for emergency dispatch or scheduled system start-ups. Our staff is equipped with the latest equipment such as OTDRs and digital scopes.



Customer Service

Taking care of our customers is priority one for Weed Instrument. We respond to all of their questions and concerns with the greatest respect. We believe it is very important to follow up on every phone call, quote and purchase order for customer satisfaction.

We have the 'can do' attitude to make sure our customers are completely confident in choosing our products for their industrial application. If you should need technical questions answered or assistance with installing our products, please contact us, and we will gladly put you in touch with one of our highly experienced Applications Engineers to make sure your questions are answered promptly.



PLC Manufacturer Programs

Alliances

Weed Instrument works closely with the leading PLC manufacturers to ensure that our fiber optic modems interface properly with their products. We are members of Rockwell Automation's Encompass program, GE-Fanuc's Accompany program, and Schneider Electric's Alliances program.



Corporate Profile

Weed Instrument Company is a leading supplier of instrumentation and control equipment for industrial, process and power control applications. Through constant innovation, the company has rapidly expanded since 1968 to become a leading supplier of accurate and reliable sensing devices and data communications equipment for harsh industrial environments. Sensing products include temperature sensors, switches and transmitters. Weed Instrument specializes in a wide range of fiber optic and custom products, and provides field support for plant communications, instrumentation, and control applications.

The Fiber Optic division of Weed Instrument was established through acquisition of two pioneering companies in the application of fiber optic technology to the industrial market, EOTec (from 3M) and APEC. Both companies had over ten years of experience in providing fiber optic solutions specific to factory automation and process control. Weed Instrument is continuing this pioneering spirit through such achievements as being the first company to receive FM Approval for fiber optic based products in hazardous areas and developing new technologies such as bi-directional communications over a single fiber.



Our staff is comprised of individuals from the I&C industry, and has a good understanding of the needs and problems specific to industrial applications. We provide complete systems product support including conceptual design, design engineering, manufacturing, testing, field installation, maintenance and calibration. Currently, Weed Instrument Company has manufacturing, testing and engineering facilities located in Round Rock, Texas.

Fiber optic products are available immediately from stock.

www.weedinstrument.com

Weed Instrument Company, Inc., P.O. Box 300, 707 Jeffrey Way, Round Rock, TX 78680

Toll Free: 1-800-880-9333, Phone: (512) 434-2850, Fax: (512) 434-2851,

E-Mail: fiberop@weedinstrument.com, Home Page: www.weedinstrument.com

Pub: RM0900515

Rev.4/2004