

# More Precision.



## optris® CTfast

Precise noncontact temperature measurement  
from -40 to 600°C



### FEATURES

- One of the smallest infrared sensors worldwide with exposure times between 3 ms (50 % signal) and 9 ms (90 % signal)
  - Fast analog output (0/4 - 20 mA, 0 - 5/10 V) with smart real time data processing
  - Instant digital 0/10 V output with a response time of 4 ms (50 % signal)
  - Continuous process monitoring with an unchopped sensor system
- Note: Conventional fast pyroelectrical infrared sensors with mechanical chopper see processes only part of the time
- Easy to assemble in multiple arrays for line scanning of small and fast objects (hot spot detection) using a bus communication
  - Rugged up to 130°C ambient temperature without cooling

General specifications	
Environmental rating	IP 65 (NEMA-4)
Ambient temperature	sensing head: -20 - 130°C electronics: 0 - 65°C
Storage temperature	sensing head: -40 - 130°C electronics: -40 - 85°C
Relative humidity	10 - 95 %, non condensing
Vibration (sensor)	IEC 68-2-6: 3 G, 11-200 Hz, any axis
Shock (sensor)	IEC 68-2-27: 50 G, 11 ms, any axis
Weight	sensing head 40 g electronics 420 g
Electrical specifications	
Analog output	0/4 - 20 mA, 0 - 5/10 V or thermocouple J, K
Digital output	0/10 V (10 mA) optional: relay: 2 x 60 V DC/42 V AC; 0.4 A; optically isolated
Digital interface (optional)	USB, RS232, RS485, CAN, Profibus DP
Output impedances	mA max. 500 Ω (with 8 - 36 V DC) mV min. 100 kΩ load impedance thermocouple 20 Ω
Inputs	programmable functional inputs for external emissivity adjustment, ambient temperature compensation, trigger (reset of hold functions)
Cable length	1 m (standard), 3 m, 8 m, 15 m
Current draw	max. 100 mA
Power supply	8 - 36 V DC

Measurement specifications	
Temperature range (scalable via programming keys or software)	-40 - 600°C
Spectral range	8 - 14 μm
Optical resolution	10:1
System accuracy (at ambient temperature 23 ±5°C)	±1 % or ±1°C <sup>1</sup>
Repeatability (at ambient temperature 23 ±5°C)	±0.5 % or ±0.5°C <sup>1</sup>
Temperature coefficient	0.05 % or 0.05°C/°C <sup>1,2</sup>
Temperature resolution (NETD)	0,5°C
Exposure time	3 ms (50 %) 9 ms (90 %)
Response time	17 ms (90 %) at analog output 4 ms (50 %) at digital output
Emissivity/Gain (adjustable via programming keys or software)	0.100 - 1.100
Transmissivity/Gain (adjustable via programming keys or software)	0.100 - 1.100
Signal processing (parameter adjustable via programming keys or software, respectively)	peak hold, valley hold, average; extended hold function with threshold and hysteresis
Certificate of calibration	optional

<sup>1</sup> whichever is greater with dynamic noise compression

<sup>2</sup> at sensing head temperature 0 - 130°C

# optris® CTfast

## Optical specifications

10:1 optics

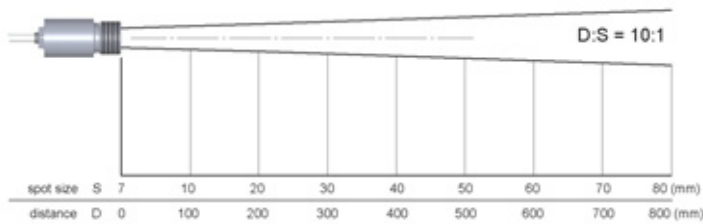

10:1 optics with CF-lens

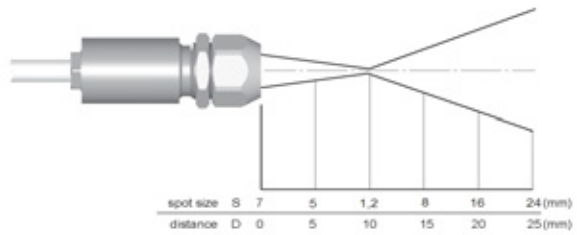

## Time constants for temperature jumps between 25°C and 180°C

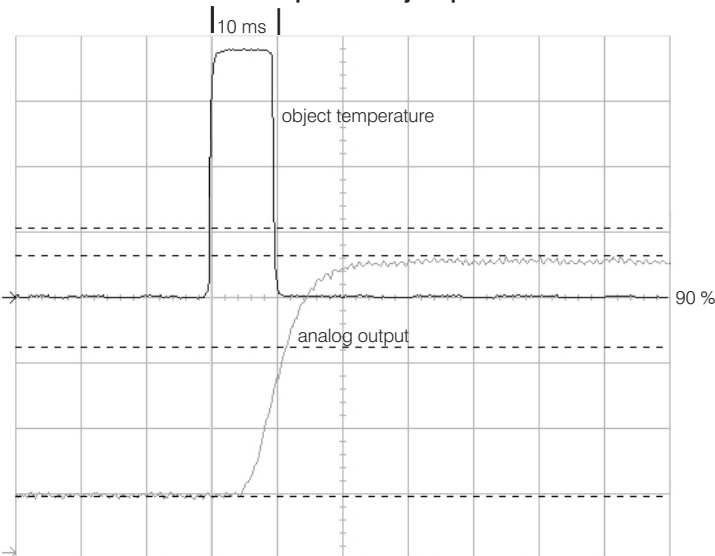

Exposure time at 90 % signal with peak hold

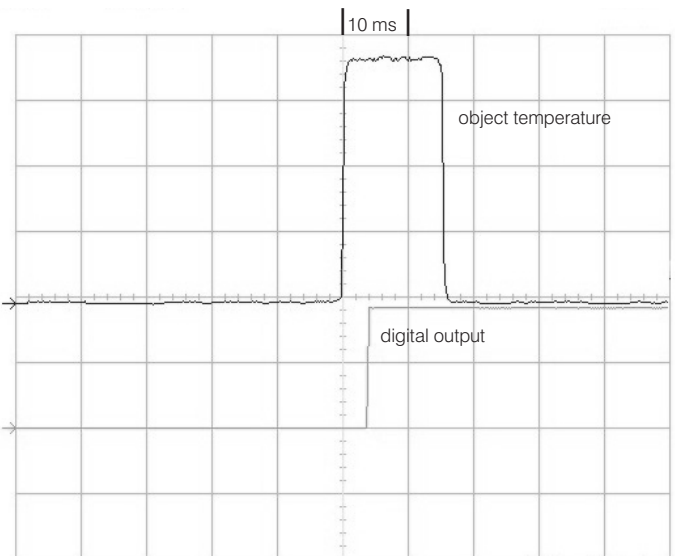

Digital output for 50 % energy threshold

## CTfast - thermal oszilloscope software

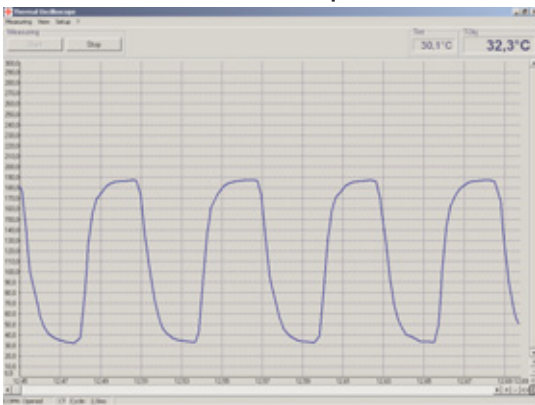

- easy sensor setup and remote controlling
- automatic data logging for analysis and documentation
- graphic display of fast temperature trends
- adjustment of extended signal processing functions
- programming of analog and digital input for external emissivity and ambient temperature compensation
- programming of alarm output (head or object temperature)
- digital remote communication of up to 32 sensors in one network

## Dimensions

### Sensing head

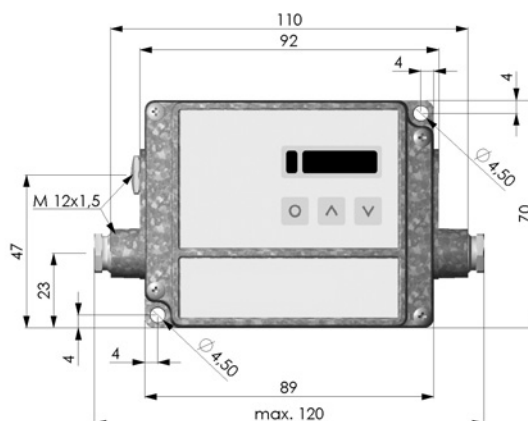
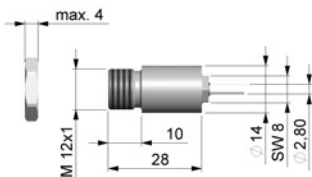

### Electronics

